

# FAN-CLUB

**Nr. 22**  
ZUM SAMMELN

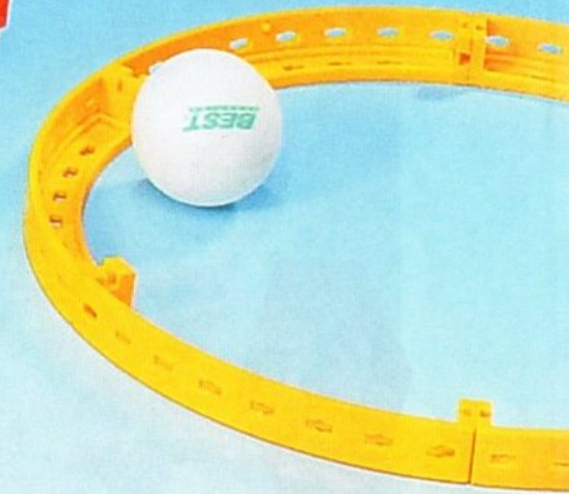
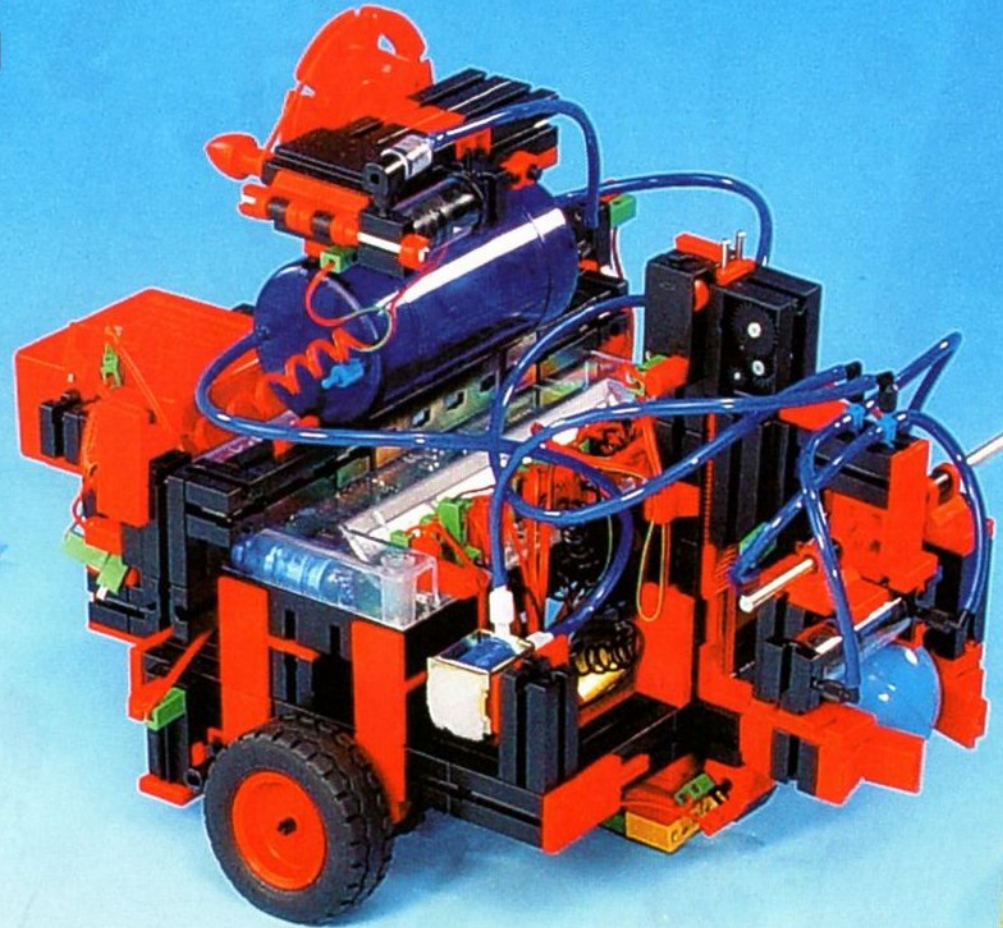
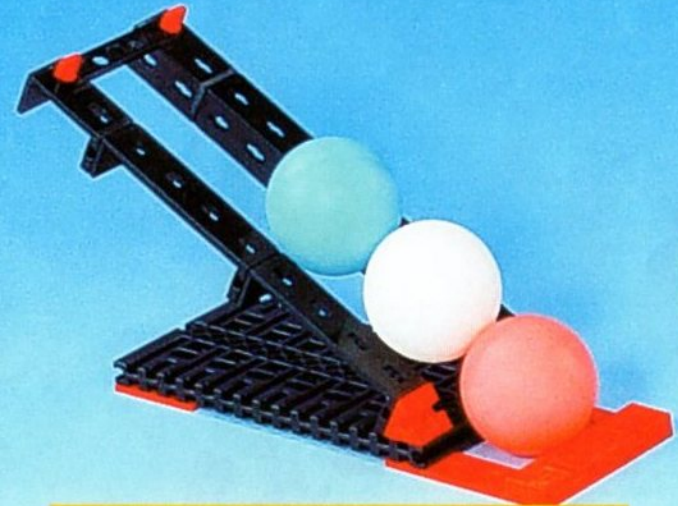

**CLUBMODELL:**  
„Mobile Pneumatic Robot“

Diesmal haben wir für Euch ein Computing-Modell entwickelt, wie es auch in der Industrie eingesetzt wird: der MPR basiert auf dem Spurensucher aus „Mobile Robots II“ und einigen Teilen aus „Pneumatic Robots“.

Das Modell kann mittels eines Pneumatic-Greifers Gegenstände (z.B. Tischtennisbälle) fassen und von einem Start- zum Endpunkt transportieren, in dem es einer schwarzen Linie folgt. Das ermöglicht der Fototransistor.

Diese Bauteile können verschiedene Lichtstärken unterscheiden, also z.B. den Unterschied zwischen schwarz und weiss. Eine Linie, die mit einem schwarzen Klebeband auf hellem Untergrund befestigt ist, genügt dem Fototransistor schon, um seinen Weg zu finden.

Diesem Prinzip folgen zum Beispiel die fahrerlosen Transportsysteme (FTS) in der Autoproduktion, die alle möglichen Fahrzeugteile oder komplette Autos wie von Geisterhand durch die Werkshallen bewegen.











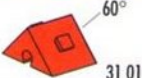











































































Falls Ihr die Version 2.10 oder 2.12 des „Intelligent Interface“ habt (erkennbar an einem entsprechenden Aufkleber auf dem Chip), benötigt Ihr noch folgende Teile, die es bei unserem Vertriebspartner Knobloch GmbH (Tel. 0 67 31/4 40 05, [www.knobloch-gmbh.de](http://www.knobloch-gmbh.de)) in einem Beutel gibt: 2 x Diode 1N4001, 2 x Flachbuchse rot (31254) und einen Flachstecker grün (31336). Diese müsst Ihr wie im rechten Kästchen neben dem Schaltplan angegeben verbinden.

Wenn die Magnetventile wie in unserem Schaltplan angeschlossen sind, muss in LLWin zur Steuerung folgendes beachtet werden: Ventil 1 entspricht Motor rechts, Ventil 2 entspricht Motor links. Der LLWin-Programmbaustein muss auf „Motor“ belassen werden.

Das LLWin-Programm für den MPR und nähere Infos zur Dioden-Schaltung erhaltet Ihr komplett in einer Datei auf unserer Homepage [www.fischertechnik.de](http://www.fischertechnik.de) unter „Computing“ > „Software“.



# Einzelteilübersicht

 31 010	4 x	 31 597	3 x	 35 031	3 x	 35 969	2 x	 37 003	1 x	 38 241	18 x
 31 011	9 x	 31 642	2 x	 35 033	2 x	 36 134	2 x	 37 034	1 x	 38 245	2 x
 31 019	1 x	 31 708	1 x	 35 049	2 x	 36 190	1 x	 37 157	2 x	 38 246	13 x
 31 021	2 x	 31 981	2 x	 35 054	6 x	 36 323	2 x	 37 237	4 x	 38 259	2 x
 31 032	1 x	 31 982	19 x	 35 055	6 x	 36 574	2 x	 37 238	2 x	 38 423	19 x
 31 036	1 x	 32 064	11 x	 35 061	2 x	 36 819	4 x	 37 272	1 x	 38 428	9 x
 31 058	3 x	 32 071	2 x	 35 063	2 x	 36 913	1 x	 37 351	1 x	 38 464	2 x
 31 060	24 x	 32 293	2 x	 35 065	2 x	 36 915	7 x	 37 457	1 x	 77 312	1 x
 31 061	10 x	 32 321	1 x	 35 090	2 x	 36 920	2 x	 37 468	6 x	 78 238	2 x
 31 124	3 x	 32 330	8 x	 35 129	1 x	 36 921	5 x	 37 679	4 x	 104 574	2 x
 31 336	30 x	 32 879	31 x	 35 214	2 x	 36 937	1 x	 37 681	1 x	 105 195	1 x
 31 337	30 x	 32 881	29 x	 35 327	2 x	 36 938	2 x	 37 783	6 x		
 31 360	1 x	 32 882	8 x	 35 328	4 x	 36 949	1 x	 37 875	1 x		
 31 422	1 x	 32 883	2 x	 35 537	1 x	 36 970	1 x	 38 216	1 x		
 31 436	4 x	 32 913	2 x	 35 945	2 x	 36 981	1 x	 38 240	1 x		

## Schlauchanschlussplan

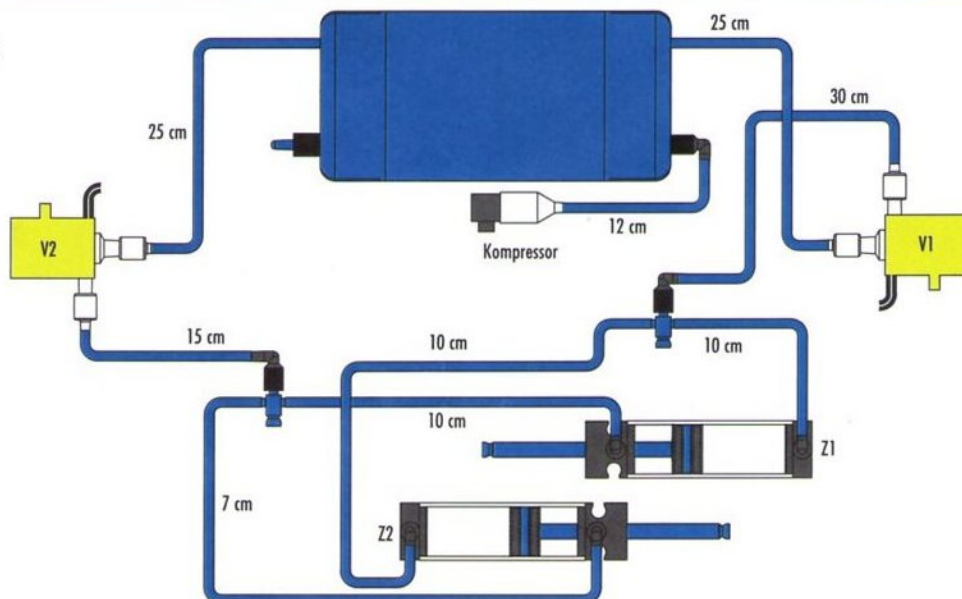

1

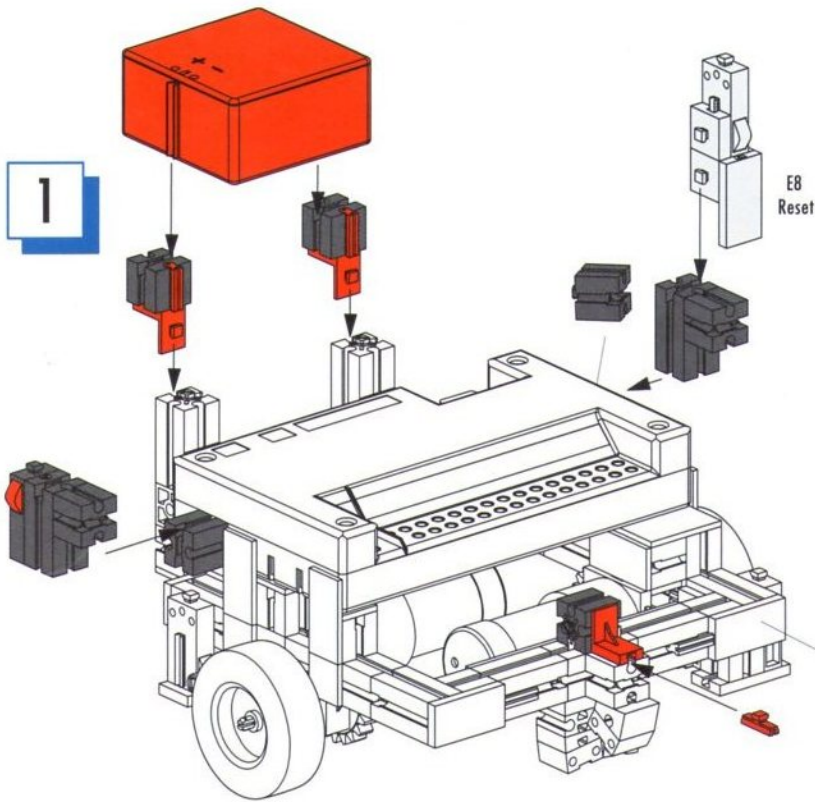

2

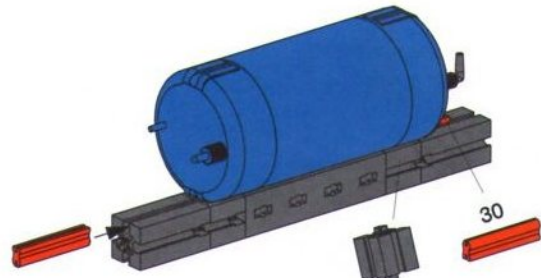

Grundmodell siehe Bauanleitung Mobile Robots II, S. 24, Spurensucher

3

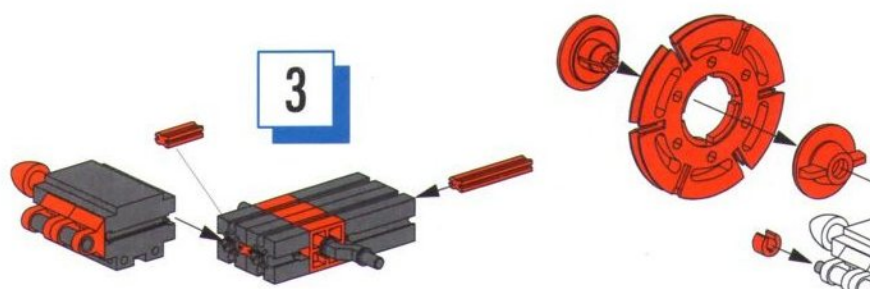

4

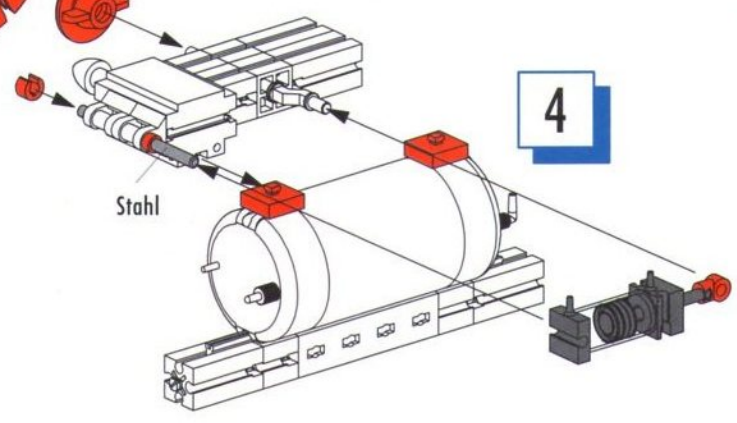

5

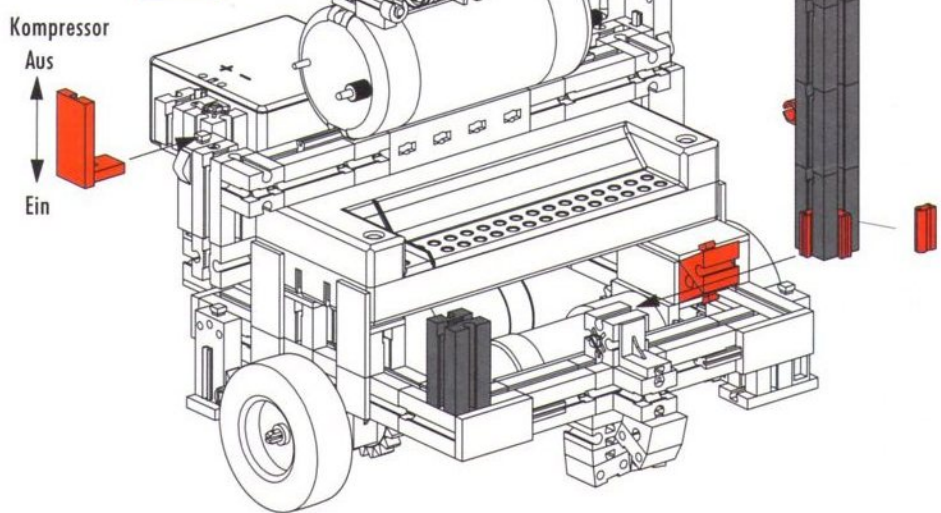



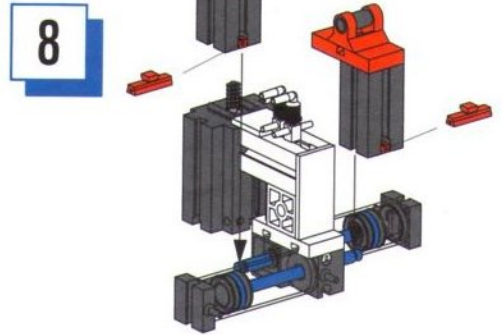
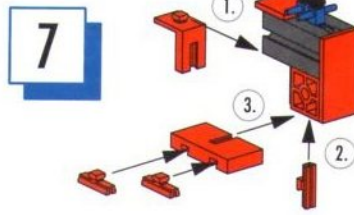
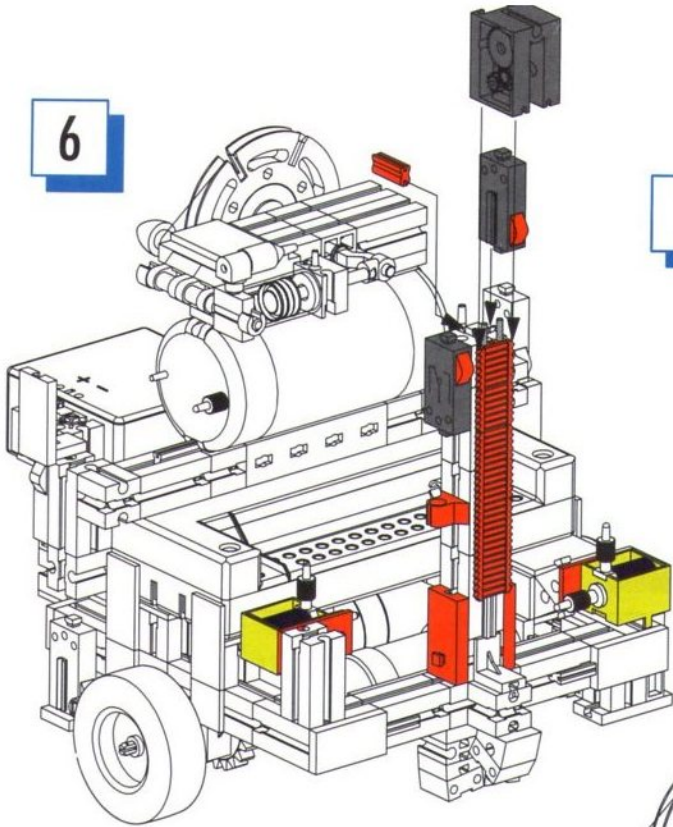

9

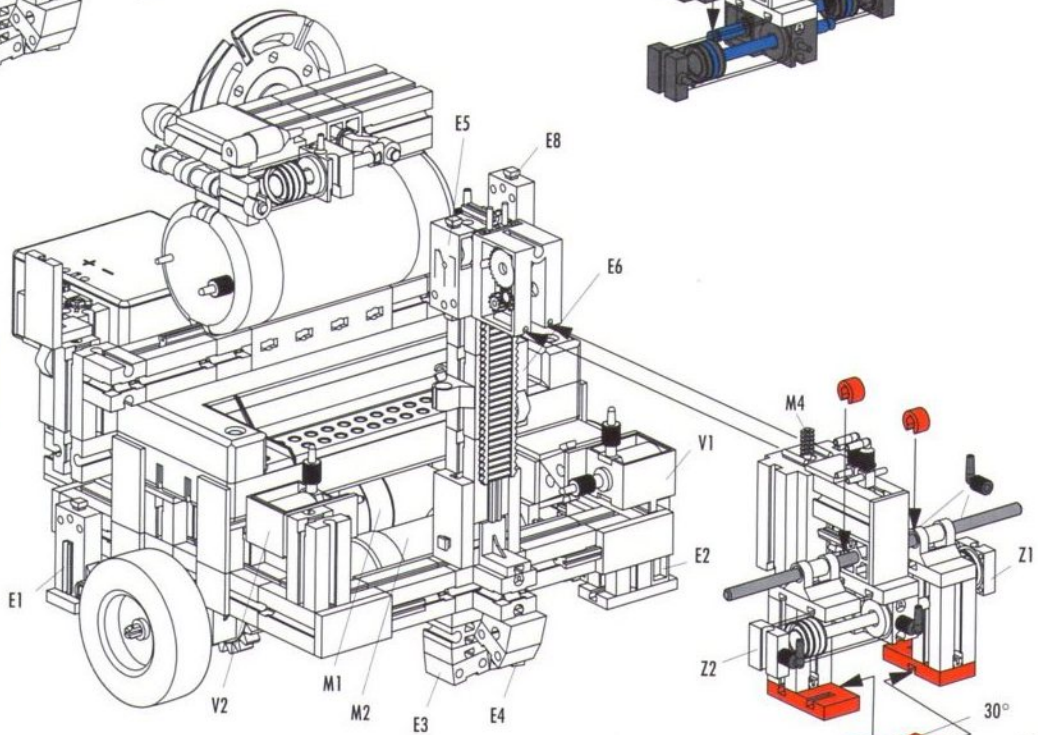

### Elektrischer Schaltplan

